



CP9 HURRICANE DOOR +/- 55 PSF QUOTE ORDER

HARDWARE INSTALLED SHEET 1 OF 2
MAX LEAF SIZE : 35-3/4" X 93-1/8"
UNITIZED SINGLE UP TO 4' X 8'

PHONE: 1-800-444-6924 - FAX: (956) 544-7943 - E-MAIL: INFO@CHEM-PRUF.COM **QUOTE BY:** _____

Date: _____ Company: _____ Contact: _____
 Telephone No.: _____ Fax No.: _____ PROJECT/OWNER: _____
 E-mail: _____ Shipping Address: _____
 Billing Address: _____

CUSTOMER NOTES:

DOOR LOCATION _____

DOOR NO. _____ INTERIOR EXTERIOR

DOOR SIZE

SINGLE DOOR _____ W x _____ H WALL OPENING _____ W x _____ H

DOUBLE DOOR _____ W x _____ H WALL OPENING _____ W x _____ H

COLOR STD. COLORS

- FDA WHITE LIGHT GREY
 CAMEL TAN DARK BROWN

- C.P. OPTION COLOR No. _____
 (SEE COLOR CHART)
 CUSTOM COLOR
 NAME: _____

HAND OF DOOR

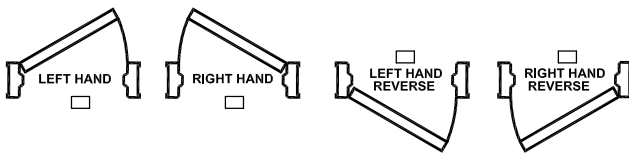

SINGLE DOOR

INSIDE

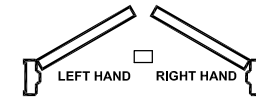

- LEFT DOOR ACTIVE PASSIVE
 RIGHT DOOR ACTIVE PASSIVE

- LEFT DOOR ACTIVE PASSIVE
 RIGHT DOOR ACTIVE PASSIVE

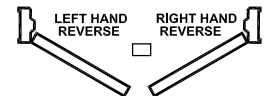

DOUBLE DOOR

KEY SIDE / OUTSIDE - YOU ARE HERE

DOOR FINISH

- STD. FINISH SEMIGLOSS
 HIGH GLOSS LEATHER
 EGGSHEEL MATTE HAMMERED
 FINE PEBBLE CUSTOM
 TREEBARK OTHER: _____

WALL MATERIAL

- CONCRETE MASONRY STEEL
 WOOD OTHER: _____
 METAL STUD
 WALL THICKNESS: _____

FRAME STYLES

STYLE 4

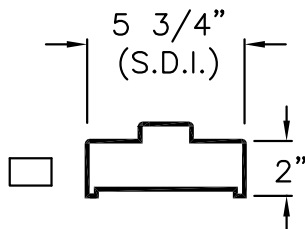

OPTION FRP TRIM

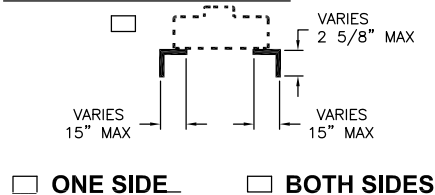

PHONE: 1-800-444-6924 / FAX: (956) 544-7943

FORM AT WWW.CHEM-PRUF.COM/ORDERFORMS ORDER FORM SHEET 1 OF 2

E-MAIL: INFO@CHEM-PRUF.COM

PHONE: 1-800-444-6924 - FAX: (956) 544-7943 - E-MAIL: INFO@CHEM-PRUF.COM **QUOTE BY:** _____

DOOR LITES

WXL RUGGED WINDOW & RETAINER

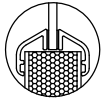

WXL RUGGED DOOR LITE _____ W x _____ H

MAX AREA : 792 SQ IN

SLIMLINE WINDOW & RETAINER



SLIMLINE DOOR LITE _____ W x _____ H

MAX AREA : 792 SQ IN

TRANSOM

71-3/4" X 21-1/2"

GLASS & GLAZING MAX AREA : 792 SQ IN

MIN THK : 9/16" LAMINATED IMPACT RATED

OTHER: _____

FRP DOOR LOUVERS MAX AREA : 576 SQ IN

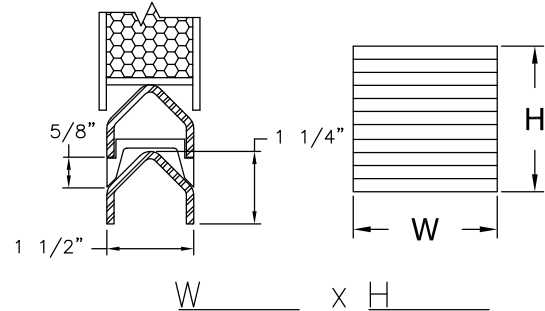

THRESHOLD SELECTIONS: PANIC TYPE NGP 896 V AL OTHER _____

LOUVER COVER : 26" X 26"

WEATHERSTRIP

- FIBERGLASS (COLOR OF DOOR)
- PEMKO S88D PEMKO S88W

ASTRAGAL FOR DOUBLE DOORS

- FIBERGLASS W/SEAL (COLOR OF DOOR)
- FIBERGLASS SPLIT SEAL (COLOR OF DOOR)
- OTHER _____

DOOR SWEEP

- FIBERGLASS (COLOR OF DOOR)
- OTHER _____

HARDWARE

SUPPLY & INSTALL

- F.M. HINGES **MIN (4) 4-1/2" X 4-1/2"**
- CONT. HINGES

ENTRY DEVICES MUST BE HURRICAN RATED

PANIC DEVICE

ACCESORIES

- CLOSER
- FLUSH BOLT
- SURFACE BOLT
- KICK PLATE
- PUSH PULL
- DOOR BOTTOM

NOTE:

****Other Hardware Options Available - Call For Details****

OTHER HARDWARE DESCRIBE:

1-800-444-6924 / FAX: (956) 544-7943

FORM AT WWW.CHEM-PRUF.COM/ORDERFORMS

E-MAIL: INFO@CHEM-PRUF.COM

ORDER FORM SHEET 2 OF 2