

MORTISE LOCK DETAIL

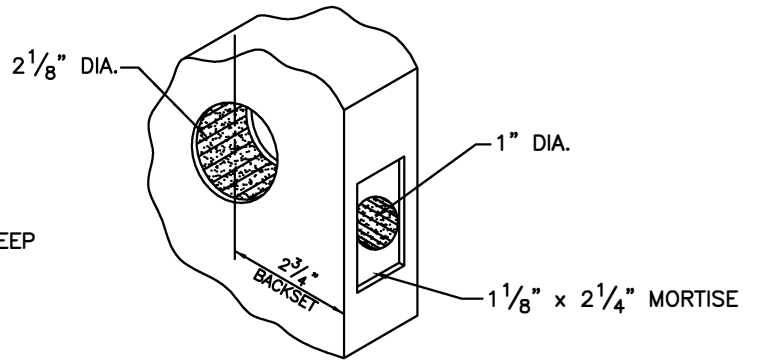

CYLINDRICAL LOCK DETAIL

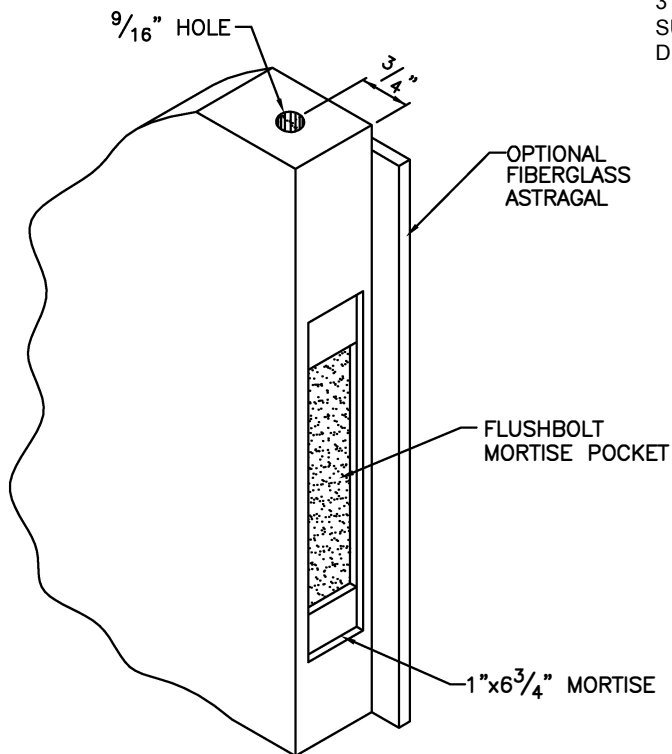

FLUSHBOLT DETAIL

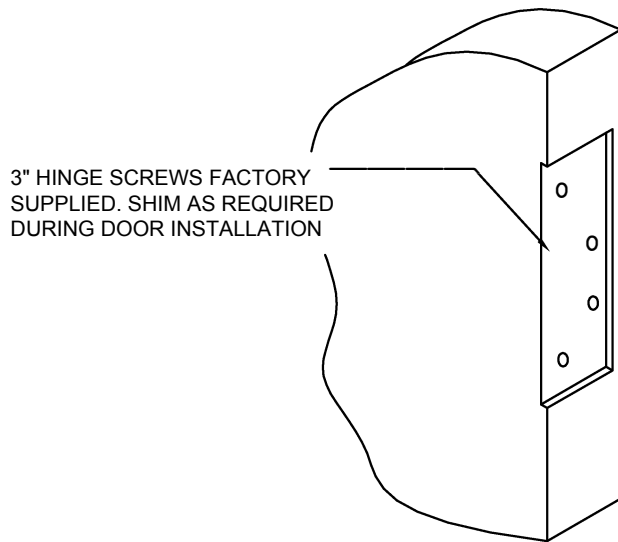

HINGE DETAIL



FIBERGLASS DOOR HARDWARE MACHINING DETAILS		
DATE 4/15/20	SCALE NONE	
DWG NAME DOORMACHDETAIL	DRAWN BY BG	