

OPTION TA5
INTERIOR VIEW LOOKING UP

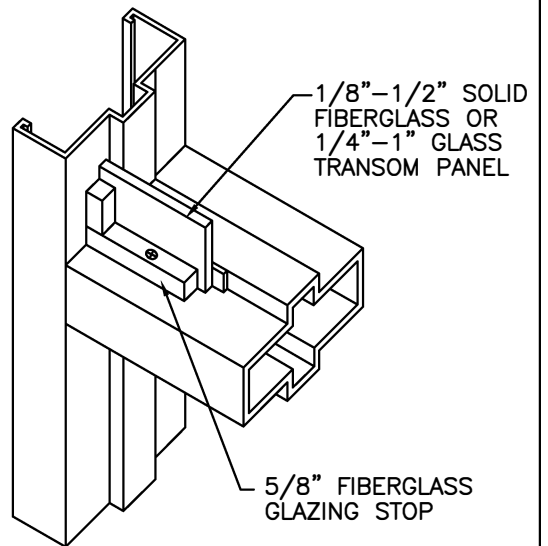

OPTION TA6
INTERIOR VIEW LOOKING DOWN

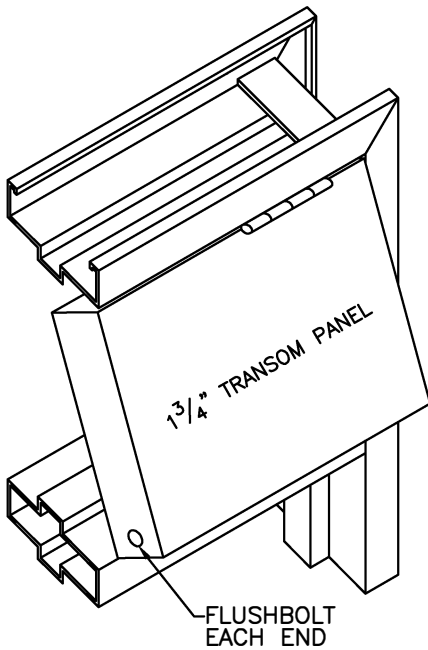

OPTION TA7
INTERIOR/EXTERIOR
VIEW LOOKING DOWN

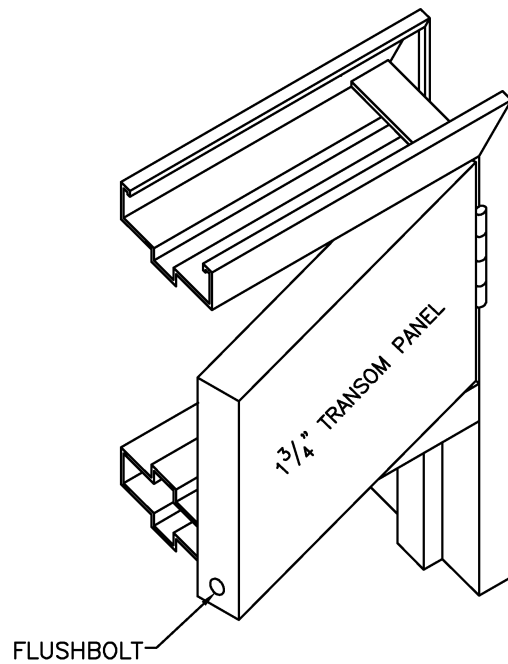

OPTION TA8
INTERIOR/EXTERIOR
VIEW LOOKING DOWN



FIBERGLASS TRANSOM TYPES AND ATTACHMENT METHODS		
DATE	SCALE	
2/25/20	NONE	
DWG NAME	DRAWN BY	
TRANSOMATTACH2	BG	