

(A)

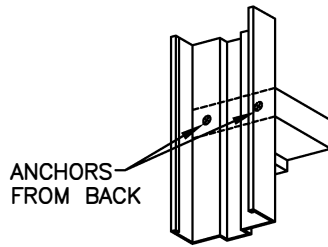

(B)

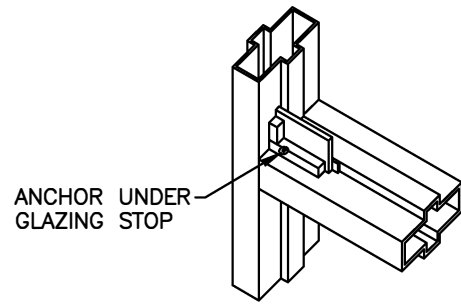

(C)

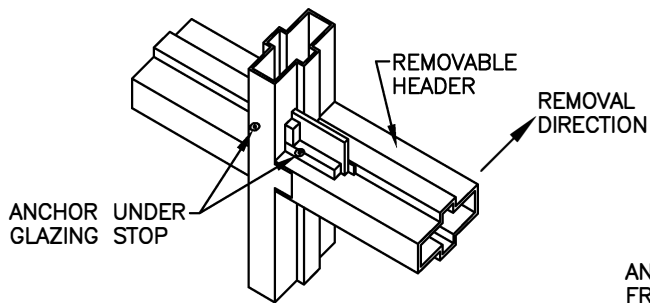

(D)

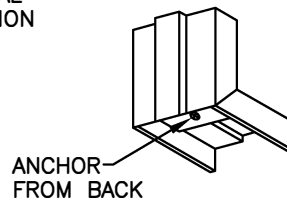

(E)



FIBERGLASS FIXED SASH/SIDELITE CONNECTIONS		
DATE 2/25/20	SCALE NONE	
DWG NAME SASHCONNECT	DRAWN BY BG	